

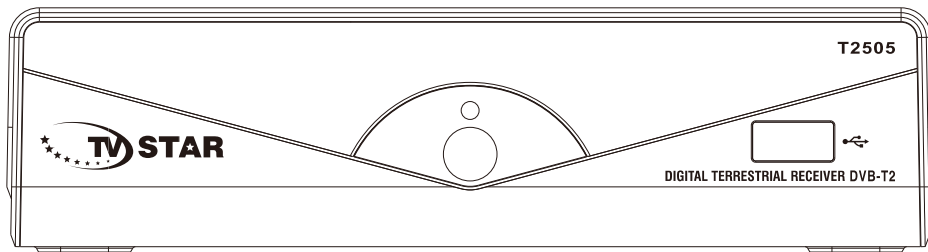

High Definition Digital Receiver

**T2505**





USER MANUAL





## Important Safety Instructions

- 1) Read these instructions.
- 2) Keep these instructions.
- 3) Heed all warnings.
- 4) Follow all instructions.
- 5) Do not use this apparatus near water.
- 6) Clean only with dry cloth.
- 7) Do not install near any heat sources such as radiators, heat registers, stoves, or other apparatus (including amplifiers) that produce heat.
- 8) Operate this product only from the type of power source indicated on the label. If you are not sure of the type of power connected to your home, consult your local power company. Disconnect the unit from the mains before any maintenance or installation procedure.
- 9) Protect the mains cord from damage and stress.
- 10) Only use attachments/accessories specified by the manufacturer.
- 11) Unplug this apparatus during lightning storms or when unused for long periods of time.
- 12) Refer all servicing to qualified service personnel. Servicing is required when the apparatus has been damaged in any way, including damage to the mains cord or plug, if the unit has been exposed to liquid or moisture, has been dropped or is not operating correctly.
- 13) Do not impede the air flow into the unit by blocking the ventilation slots.
- 14) Attention should be drawn to the environmental aspects of battery disposal.
- 15) Use the apparatus in moderate climate.



**WARNING:** To reduce the risk of fire or electric shock, do not expose this apparatus to rain or moisture.

**WARNING:** The batteries shall not be exposed to excessive heat such as direct sun light, fire, etc.





This symbol indicates that dangerous voltages constituting a risk of electric shock are present within this unit.



This symbol indicates that there are important operating and maintenance instructions in the literature accompanying this unit.



This symbol indicates that this product incorporates double insulation between hazardous mains voltage and user accessible parts. When servicing use only identical replacement parts.



This symbol on the product or in the instructions means that your electrical and electronic equipment should be disposed at the end of life separately from your household waste. There are separate collection systems for recycling. For more information, please contact the local authority or your retailer where you purchased the product.

## Table of Contents

Front and Rear Panel .....	1
Remote Control.....	2
Connecting to a Television.....	4
First Time Installation.....	5
Troubleshooting.....	16
Technical Specifications.....	17

### Package Contents

Before installation, please check the contents of the package.  
The package should contain the following items:

- |                                      |         |
|--------------------------------------|---------|
| ① DVB-T TV Receiver                  | x1 pc   |
| ② Remote Control                     | x1 pc   |
| ③ AAA Battery for the Remote Control | x1 pair |
| ④ User Manual                        | x1 pc   |

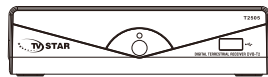

DVB-T TV Receiver



Remote Control

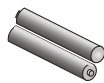

AAA Battery

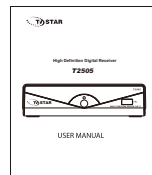

User Manual

## Front and Rear Panel

### 1. Front panel

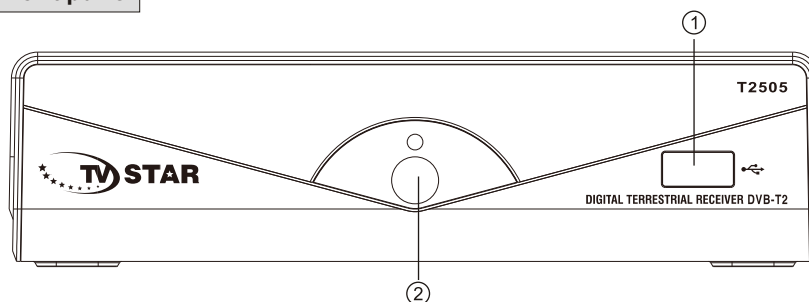

- ① **USB:** For software upgrade and media playback.
- ② **REMOTE CONTROL SENSOR:** Used to receive the signal from the Remote Control.

### 2. Rear panel

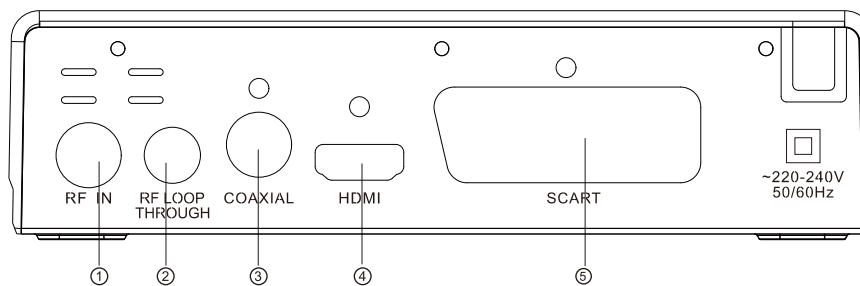

- ① **RF IN:** This socket connects to your external Aerial.
- ② **RF LOOP THROUGH:** This socket will feed the RF signal to either your TV or another video system.
- ③ **COAXIAL**
- ④ **HDMI:** High definition audio and video output used to connect to a HDMI device
- ⑤ **SCART**

## Remote Control



- POWER:** Switch the receiver in and out of Standby mode.
- <0>-<9>:** Numeric keys.
- CH-/CH+:** Program changing keys.
- MENU:** Display main menu on TV screen, and press again to disappear menu.
- OK:** To confirm current setting, or display all programs in no-menu mode.
- VOL-/ VOL+:** To increase / decrease volume.  
: Press to move the cursor
- EPG:** Shows the Electronic Program Guide.
- FAV:** Displays your favorite channels list.  
Press FAV again to access to the other favorite lists.
- V-FORMAT:** Switch the HDMI 720P and 1080i.
- RECALL:** Go back to the previous viewed channel.
- Red/green/yellow /blue:** Use to navigate between pages in teletext mode.
- TTX:** Switch on Teletext, if current channel has this option, and use EXIT key to quit Teletext.
- SUBTITLE:** Display subtitle options (availability depends on the channel).
- LANG:** Change the Audio language and Left/Right channel (availability depends on the channel).
- EXIT:** Use this key to quit current menu.
- INFO:** Display information about the current channel.
- TV/RADIO:** Switch between Digital Radio and DVB-T modes.
- MUTE:** To navigate inside the menus.
- PAGE+/PAGE -:** To navigate inside the menus.
- ASPECT:** Switch 4:3/16:9.
- TIMESHIFT:** See page 16
- ZOOM**
- LIST**
- GOTO**
- REPEAT**
- TIMER**

### Multimedia keys:

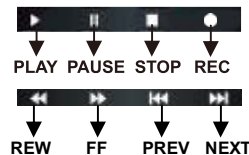

### Installing the Batteries

Remove the battery cover from the rear of the Remote Control and place 2xAAA size batteries inside the compartment. Please make sure the battery polarities match the polarity markings inside the compartment.

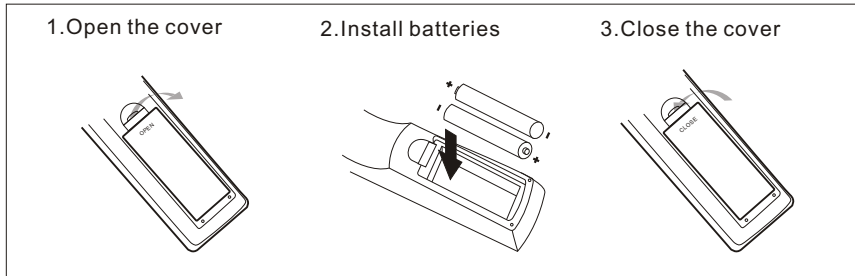

### Using the Remote Control

To use the Remote Control, point it towards the front of the Digital Set Top Box. The Remote Control has a range of up to 7 metres from the Set Top Box at an angle of up to 60 degrees.

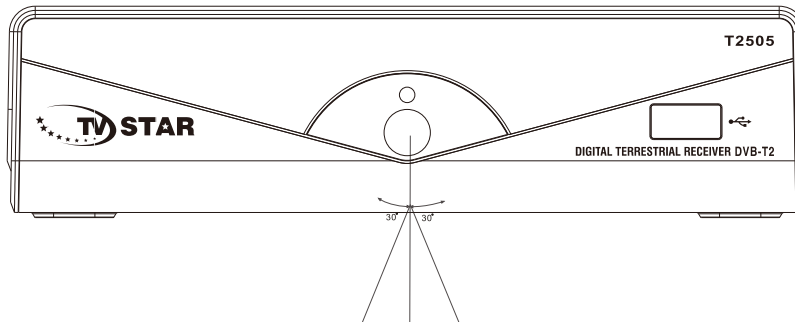

The Remote Control will not operate if its path is blocked.



**Sunlight or very bright light will decrease the sensitivity of the Remote Control.**

## Connecting to a Television

For a basic connection from your Set Top Box to the television, use the Composite connection outlined below.  
For a higher quality connection, use the Component Video connection outlined below combined with the Composite Audio Connection.  
For the highest quality connection use a direct HDMI connection, see below.

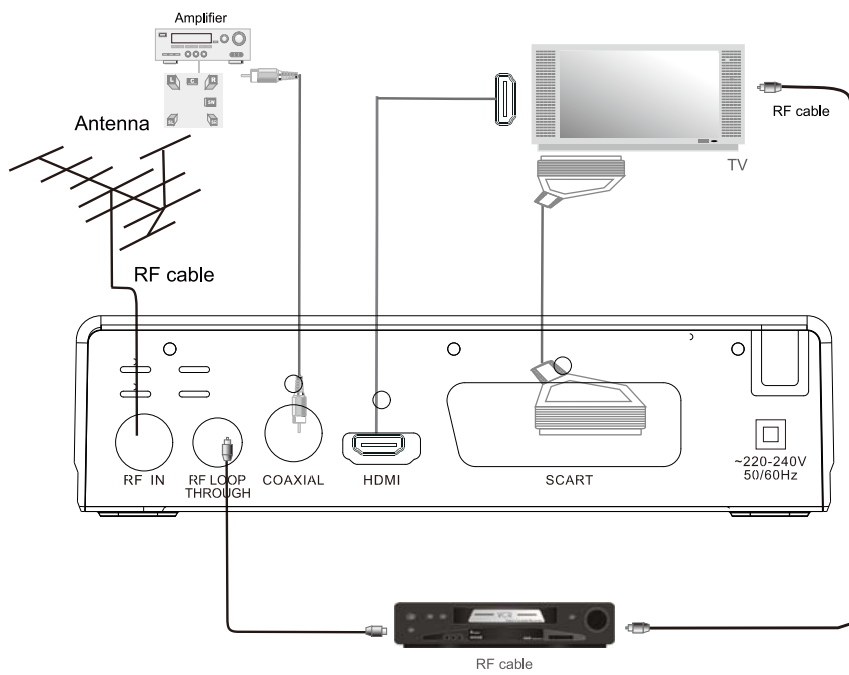



## First Time Installation

After all connections have been made properly, switch on TV and make sure the unit is connected to the Main Power. Press Power button to switch the unit on. If you are using the unit for the first time or have restored the unit to Factory Default, the Installation Guide Menu will appear on your TV screen.



- (1) [OSD Language] press RIGHT/LEFT key to select a language.
- (2) [Country] press RIGHT/LEFT key to select your country of residence.
- (3) [Channel Search] press RIGHT or OK key to begin Automatic channel search.
- (4) Once channel tuning is complete, you can start watching TV programs.

## Basic Operation

### (1). Program Manage Settings

To access the Menu, press the MENU button and select [Program]. using the RIGHT/LEFT keys to navigate through the menu. The Menu provides options to adjust the Program Manage Settings. Select an option and press OK or RIGHT to adjust that setting. Press the EXIT button to exit the Menu.



### (a) Program Edit

To edit your program preferences (lock, skip, favourite, move or delete), you will need to enter the Program Edit Menu. This Menu requires a password to access. Enter the default password '000000'. The master unlock password is '888888'.



### Set Favourite Channels

You can create a shortlist of favourite programs that you can easily access. Set Favourite TV or Radio program:

1. Select your desired channel then press the FAVOURITE button.  
A heart-shaped symbol will appear and the channel is marked as a favourite.
2. Repeat the previous step to select more Favourite channels.
3. To confirm and exit the Menu, press the EXIT key.

### Disable Favourite TV or Radio Channel:

Select the Favorite channel and press Favorite button on the remote control to cancel.

### View Favourite Channel

1. While in normal viewing mode, press Favourite button and the Favourite Menu will appear.
2. Press UP/DOWN to browse through your Favourite Channels.
3. Press OK to select your favourite channel.

### Delete a TV or Radio Program

1. Select the Program and then press the BLUE button.  
A warning message will appear. Press OK to delete the channel.
2. Repeat the previous step to select more channels to delete.

### Skip TV or Radio Channel

1. Select the channel you would like to skip and press the GREEN button.  
A skip symbol is displayed. The channel is marked as a skip.
2. Repeat the previous step to skip more channels.
3. To save your settings and exit the menu, press EXIT key.

### Disable the Skip Channel function:

Select the Skip channel and press the GREEN button on the remote control to cancel.

### Move a TV or Radio Program

1. Select the preferred channel then press the RED button. A move symbol will appear.
2. Press UP/DOWN to move the channel.
3. Press OK to confirm.
4. Repeat the above steps to move more channels.

### Lock Program

You can lock selected programs for restricted viewing.

Lock a TV or Radio channel:

1. Select the preferred channel then press the YELLOW button. A lock-shaped symbol is displayed. The channel is now marked as locked.
2. Repeat the previous step to select more channels.
3. To confirm your settings and exit the menu, press the EXIT button.
4. Press the YELLOW button to disable the locked channels function.
5. To view the locked channels, you will be required to enter either the default password '000000' or your last set password. The master unlock password is '888888'.

### b) EPG (Electronic Programming Guide)

This feature shows the TV program listings for each channel for the following 7 days. By default, when the EPG is opened, the current channel's listings are shown. To view listings for other channels, press the LEFT and RIGHT arrow keys. The display shows the buttons to press to go forward or backward in the programs listing.

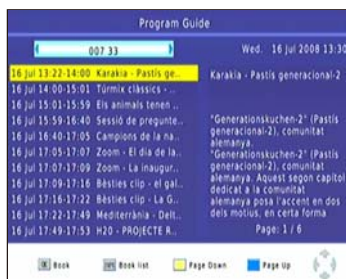

Note: Please see section (d) "Scheduling" to learn how to schedule program recordings and channel preview.

### Preview Channel:

To set the receiver to change to a channel at a specific time (e.g. at the start of your favourite program) while you are watching another channel, please follow these steps:

- Press EPG to open the full listings.
- Select the TV channel using the LEFT / RIGHT arrow keys.
- Select the TV program you want to watch later.
- Press OK. On the window that pops up, you are able to modify the channel, date and time, as well as optionally selecting to repeat this action on a regular basis.
- Select "View" in the "Mode" option.
- Press EXIT.

- Select "View" in the "Mode" option.
- Press EXIT.

A few seconds before changing channels, a warning message with a count-down is displayed on screen, which will change to the programmed channel when the count-down ends.

### (c) Sort

Sort your channels from the following options:

- [By LCN] - Sort the channels in ascending order.
- [By Service Name] - Sort the channels in alphabetical order.
- [By Service ID] - Sort the channels according to the station.
- [By ONID] - Sort the channels according to ONID.

### (d) LCN (Logical channel number)

Set LCN on or off.

## (2). Picture Setting

To access the Menu, press MENU then select [Picture] using the RIGHT/LEFT key. The Menu provides options to adjust the video settings. Press UP/DOWN to select an option and press RIGHT/LEFT to adjust that setting. Press EXIT to exit the menu.



### (a) Resolution

You can change this setting if the picture resolution does not appear to be correct. This setting is to match the most common setting for HDMI.

- [480P]: for NTSC TV system.
- [576P]: for PAL TV system.
- [720P]: for NTSC or PAL TV system.
- [1080I]: for NTSC or PAL TV system.

### (b) TV Format

If the picture does not appear to be correct you can change this setting.

This should match the most common setting for TVs in your country.

- [NTSC]: for NTSC system TV.
- [PAL]: for PAL system TV.

## (3). Channel Search

To access the menu, press MENU and select [Search Channel] using the RIGHT/LEFT keys.

This Menu provides options to adjust the Search Channel settings.

Press UP/DOWN to select an option and press RIGHT/LEFT to adjust the settings. Press EXIT to exit the Menu



**(a) Auto Search**

This option will automatically search for channels and save them once the scanning is complete. All previously saved channels and settings will be deleted.

1. Select [Auto Search] and press OK or RIGHT to start channel search.
2. To cancel channel search, press EXIT. Any channels that have been found will be saved.



**(b) Manual Search**

This option allows you to scan for new channels without deleting previously saved channels and settings.

1. Select [Manual Search] then press OK or RIGHT. The channel search screen will appear.



2. Press the RIGHT/LEFT key to select the channel frequency.
  3. Press OK to start searching channels.
- If a channel is found, it is saved and added to the channels list. If channels can not be found during searching, the unit will exit automatically.

**(c) Country**

Select your country of residence.

**(d) Antenna Power**

Enable Antenna Power if an external active antenna is connected.

**(4).Time Setting**

To access the Menu, press MENU then select [Time] using the RIGHT/LEFT keys. The Menu provides options to adjust the time settings.

Press UP/DOWN to select an option and press RIGHT/LEFT to adjust the settings. Press EXIT to exit the menu



**(a) Time offset**

Select auto or manual for GMT offset adjustments.

**(b) Country Region**

Select the Country Region when [Time Offset] is set to Auto.

**(c) Time Zone**

Select the Time Zone Offset when [Time Offset] is set to Manual.

**(5). Option**

To access the Menu, press MENU and select [Option] using the RIGHT/LEFT keys. The menu provides options to adjust the OSD Language, Subtitle Language and Audio Language.

Select an option and press RIGHT/LEFT to adjust the setting.

Press EXIT to exit the Menu



**(a) OSD (On Screen Display) Language**

Select an OSD language.

**(b) Subtitle Language**

Select the preferred subtitle language.

**(c) Audio Language**

Select the preferred audio language for watching TV channels.

If the language is not available, the default program language will be used.

**(6). System Setting**

To access the Menu, press MENU and select [System] using the RIGHT/LEFT keys. The menu provides options to adjust the system settings.

Press the UP/DOWN key to select an option and press RIGHT/LEFT to adjust the setting. Press EXIT to exit the Menu .



**(a) Set Password**

Set or change the password for locked programs. Enter your old password or the default password '000000'. You will then be asked to enter your new password. Press OK button to confirm your new password.

Once it is confirmed, press EXIT to exit the Menu. The master unlock password is '888888'.

**(b) Restore Factory Default**

Reset your Set Top Box to the Default Factory Settings.

In Main Menu select [Restore Factory Default] using the RIGHT/LEFT keys and press OK or RIGHT to select. Enter your password or the default password '000000' and press OK to confirm. This option will delete all preset channels and settings. The master unlock password is '888888'.

### (c) Information

View model, hardware and software information.

### (7). USB

To access the Menu, press the **MENU** button and select [USB] using the RIGHT/LEFT keys. The menu provides options to playback Music, Photo and Multimedia files. It can support AVI, MP3, WMA, JPEG and BMP formats. The unit will only support USB device with FAT32 / NTFS file system.



**(a) Multimedia:** When a USB device is attached you can select from the Music, Photo or Movie options in this menu using the RIGHT/LEFT keys and OK to select. If a USB device is not connected, the warning message "Not find any usb Device" will appear.





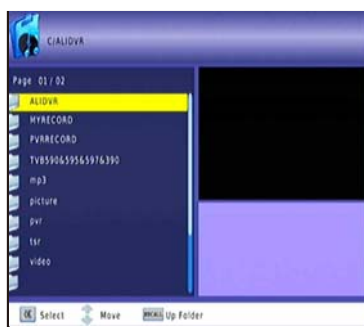

**(b) Photo configure:**

- Slide Time:** adjust slide show interval to 1~8 seconds.
- Slide Mode:** adjust slide show effect as mode 0~59 or random.
- [Keep]: Play picture in its original aspect.
- [Discard]: Play picture in full screen mode.

**(c) Movie Configure:**

- [Keep]: Play movie in its original aspect.
- [Discard]: Play movie in full screen mode.
- **Subtitle Specific:**
  - [Small]: Displays the subtitle as small mode.
  - [Normal]: Displays the subtitle as normal mode.
  - [Big]: Displays the subtitle as big mode.
- **Subtitle BG:**
  - [White]: Displays the subtitle in white background.
  - [Transparent]: Displays the subtitle in transparent background.
  - [Grey]: Displays the subtitle in grey background.
  - [Yellowgreen]: Displays the subtitle in yellowgreen background.
- **Subtitle Font Color:**
  - [Red]: Displays Subtitle in red font.
  - [Blue]: Displays Subtitle in blue font.
  - [Green]: Displays Subtitle in green font.

**d) USB RECORDING.**

This function is available only when a USB storage device is connected to the receiver.

**Instant recording:**

If you want to start recording a live show, which is currently being broadcast, go to the desired channel and press the REC button. Press again to stop recording.

**Schedule a Recording:**

To schedule a recording before broadcast (e.g. record your favourite show while you're out), follow these steps:

- Press EPG to open the full listings.
- Select the TV channel using the LEFT / RIGHT arrow keys.
- Select the TV show you want to record.
- Press OK. On the window that pops up, you are able to modify the channel, date, recording start-time and recording end-time, as well as optionally selecting to repeat this action on a regular basis.



- Select "OTHER RECORDING" in the "Mode" option.
- Press EXIT.

A few seconds before starting to record, a warning message with a count-down is displayed on screen, which will change to the programmed channel when the count-down ends. Once the recording has finished, a confirmation message appears on screen.

To view the scheduled events, press the blue button.  
To delete a scheduled event, select the event and press the blue button.

The recording files can be deleted on this unit, you can go to the PVR, and press yellow button to delete it. The TV program is recorded to file at . mts format, which can be played back on this unit and PC using a suitable player, but can not be played back on DVD or PDVD

For recording the high definition TV programs, the version of usb device should be 2.0 or above, otherwise the unit may not record the hd programs correctly.

When recording to usb stick or external hard disc on this model, you have to wait a few seconds before pushing rec. after inserting the media. Otherwise the unit can freeze in the signal. If that happens, then please take off power and connect again to fix this.

Note:

Scheduled recording only works when the unit power is on, it can not work when the unit is standby.

Note:

- We cannot guarantee compatibility (operation and/or bus power) with all USB mass storage devices and assume no responsibility for any loss of data that may occur when connected to this unit.
- With large amounts of data, it may take longer for the system to read the contents of a USB device.
- Some USB devices may not be properly recognised.
- Even when they are in a supported format, some files may not play or display depending on the content.



**(e) Timeshift**



When you are playing the program, you can insert the USB, and at any time you can press the [Time shift] button, the frame will be paused, and you may press the [PLAY] button after a second, it will start to timeshift now. You may press the PLAY button to return the normal program playing, and the timeshift is continuing, you may see from the below picture's bottom which is showing the time shift status. In this case, you may make the unit to play the recorded program from the start.



## Troubleshooting

Problem	Potential Reasons	What to do
No picture	Power isn't connected	Connect the power
	The power switch is not on	Switch on the power
Screen shows "No Signal"	DVB-T cable not connected	Plug in the DVB-T cable
	Aerial cable is faulty	Check aerial cable and connections
No sound from speaker	No or incorrect connection with audio cable	Connect the audio cable correctly
	Sound on mute	Turn off mute function
Only sound, no image on the screen	No or incorrect connection with AV cable	Make sure cables are connected correctly
	The program is a radio program	Press <TV/RADIO> key to shift into TV mode
Remote Control is not responding	The battery is exhausted	Change battery
	Remote Control is not facing or close enough to the Set Top Box	Adjust the position of the Remote Control and move closer to the unit
Picture is breaking up	The signal is too weak	Check aerial cable and connections

## Technical Specifications

Item	Sub Item	Parameter
Tuner	Input Frequency	44~1002MHz
	RF Input level	-81.5~-20dBm
	IF Bandwidth	6MHz/7MHz/8MHz
	Modulation	QPSK,16QAM,64QAM,256QAM
Video	Decoder Format	MPEG4 AVC/H.264 HP@L4 MPEG2 MP@ML.HL
	Output Format	576P , 720P, 1080P, 4:3 and 16:9
	Output Port	HDMI(V1.3), Scart
Audio	Decoder Format	MPEG-1 (layer1&2&3 ), WMA, AC3
	Audio output	Coaxial
USB 2.0	Supported Capacity	500GB
	Supported Media	MP3, WMA, JPEG, BMP, AVI
Power	Supply Voltage	~110-240V50/60Hz
	Maximum Power Consumption	6 W
	Standby Power Consumption	< 0.5W
Weight	0.4 kgs	
Size	160x110x45mm	

## Notice about recycling

---



Your product is designed and manufactured with high quality materials and components which can be recycled and reused.

This symbol means that electrical and electronic equipment, at their end-of-life, should be disposed of separately from your household waste.

Please dispose of this equipment at your local community waste collection/recycling centre. In the European Union there are separate collection systems for used electrical and electronic products. Please help us to conserve the environment we live in!